



presents

For price/availability information or to place an order for any item shown, please call toll-free:
1-800-292-0179
 Monday through Friday,
 8:00 AM - 5:00 PM CST (GMT-6).

STEEL SWITCH BOXES BY



We can supply any item from Hubbell-Raco's extensive product catalog. If you don't find it here, please give us a call at 1-800-292-0179.

PAGE [1](#) [2](#) [3](#) [4](#) [PREVIOUS](#) [NEXT](#)

SWITCH BOXES GANGABLE, OLD WORK

SWITCH BOXES

**2 1/2" DEEP
GANGABLE
WITH CONDUIT KO's
12.5 CUBIC INCHES**



501

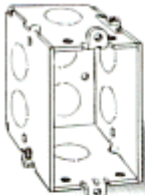

500, 503

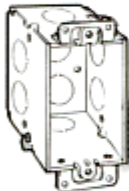

502

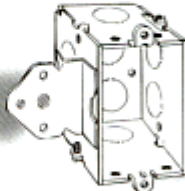

504, 505



506

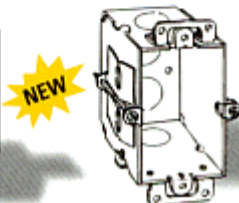

RACO NO.	DESCRIPTION BRACKET & SETBACK	KNOCKOUTS			STD. PKG.
		SIDES	ENDS	BOTTOM	
500	Ears	4 - 1/2"	2 - 1/2"	2 - 1/2"	50
8500	Ears	4 - 1/2"	2 - 1/2"	2 - 1/2"	50
503	Ears	4 - 3/4"	2 - 3/4"	2 - 1/2"	50
501	Ears	4 - 1/2"	2 - 1/2"	2 - 1/2"	50
504	TS brkt., 1/2"	2 - 1/2"	2 - 1/2"	2 - 1/2"	50
8504	TS brkt., 1/2"	2 - 1/2"	2 - 1/2"	2 - 1/2"	10
505	TS brkt., 1/2"	2 - 1/2"	2 - 3/4"	2 - 1/2"	50
506	B brkt., 1/8"	4 - 1/2"	2 - 1/2"	2 - 1/2"	10
	Old work, Tigerrip		2 - 1/2"	2 - 1/2"	20

APPLICATIONS:

OLD WORK SWITCH BOXES

- Wiring method may be conduit or cable connector.

PRODUCT FEATURES:

OLD WORK SWITCH BOXES

- Gangable switch boxes offer the option of constructing a box to hold two or more devices.
- Bracketed boxes provide fast and accurate means to mount the box to wood or metal studs.
- Plaster ears allow the box to be used in "old work" applications.

COMPLIANCES

[Click here](#) for complete information on UL and other compliances that apply to these products.

OLD WORK SWITCH BOXES

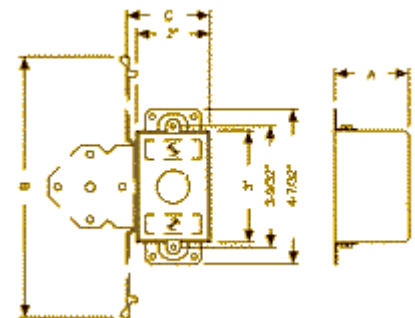

RACO NO.	A	B	C
500	2-1/2"	--	--
503	2-1/2"	--	--

SWITCH BOX
2 1/2" DEEP
NONGANGABLE
WITH CONDUIT KO's
12.5 CUBIC INCHES



508



RACO NO.	DESCRIPTION BRACKET & SETBACK	KNOCKOUTS			STD. PKG.
		SIDES	ENDS	BOTTOM	
508	Old work		2 - 1/2"		20

501	2-1/2"	--	--
504	2-1/2"	7-5/32"	2-5/16"
502	2-1/2"	2"	4"
506	2-1/2"	--	--
508	2-1/2"	--	--

SWITCH BOXES
NONMETALLIC SHEATHED CABLE CLAMPS

SWITCH BOXES
2 1/2" DEEP
GANGABLE - WITH
NONMETALLIC SHEATHED
CABLE CLAMPS
12.5 CUBIC INCHES

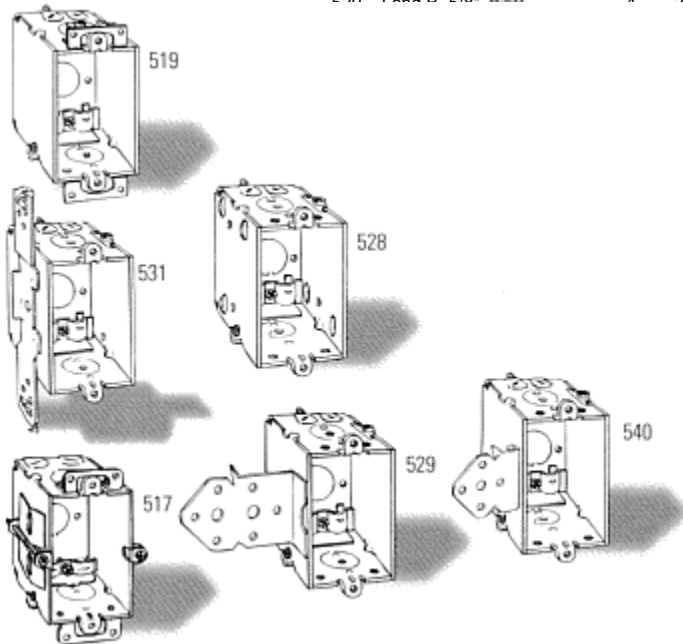

RACO NO.	DESCRIPTION BRACKET & SETBACK	KNOCKOUTS			STD. PKG.	
		SIDES	ENDS	BOTTOM		
519	Ears		4	1 - 1/2"	50	
8519	Ears		4	1 - 1/2"	50	
528	Level bumps		4	2 - 1/2"	1 - 1/2"	50
8528	Level bumps		4	2 - 1/2"	1 - 1/2"	50
531	TS brkt., 1/2"		4	2 - 1/2"	1 - 1/2"	50
8531	TS brkt., 1/2"		4	2 - 1/2"	1 - 1/2"	50
528	B brkt., 1/4"		4	2 - 1/2"	1 - 1/2"	50
529	Level Bump		4	2 - 1/2"	1 - 1/2"	50
				1 - 1/2"	20	

APPLICATIONS:
STEEL SWITCH BOXES

- Wiring method may be conduit or cable connector.

PRODUCT FEATURES:
STEEL SWITCH BOXES

- Gangable switch boxes offer the option of constructing a box to hold two or more devices.
- Bracket boxes provide fast and accurate means of mounting the box to wood or metal studs.
- Plaster ears allow the box to be used in "old work" applications.

COMPLIANCES

[Click here](#) for complete information on UL and other compliances that apply to these products.

STEEL SWITCH BOXES

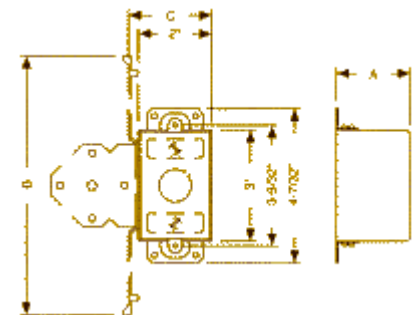

RACO NO.	A	B	C
519	2-1/2"	--	--
528	2-1/2"	--	--
531	2-1/2"	7-5/32"	2-5/16"
540	2-1/2"	1-1/32"	5-3/64"
529	2-1/2"	1-31/32"	5-3/64"
517	2-1/2"	--	--
596	2-1/2"	--	--
545	2-1/2"	--	--

SWITCH BOXES
2 1/2" DEEP
NONGANGABLE - WITH
NONMETALLIC SHEATHED
CABLE CLAMPS
12.5 CUBIC INCHES

RACO NO.	DESCRIPTION BRACKET & SETBACK	KNOCKOUTS			STD. PKG.	
		SIDES	ENDS	BOTTOM		
596			4	2 - 1/2"	1 - 1/2"	50
545	Old work		4	2 - 1/2"		20

CAT. NO. 355 SWITCH BOX

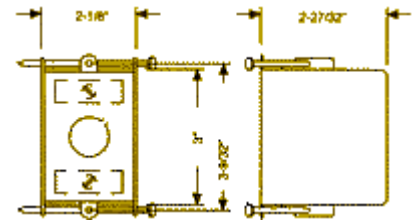
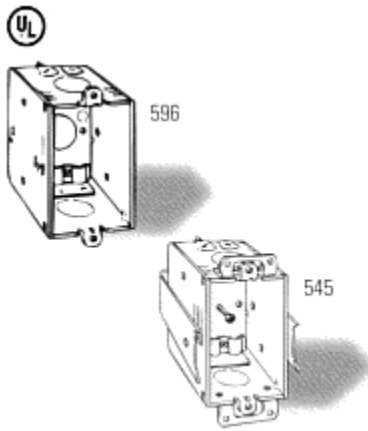

SWITCH BOX

2²⁷/₃₂" DEEP
NONGANGABLE - WITH
NONMETALLIC SHEATHED
CABLE CLAMPS
15.8 CUBIC INCHES

RACO NO.	DESCRIPTION BRACKET & SETBACK	KNOCKOUTS				STD. COND. PKG.
		SIDES	ENDS	BOTTOM	COND.	
355	S brkt., nails	4	1 - 1/2"	50		
8355	S brkt., nails ■■■■	4	1 - 1/2"	20		

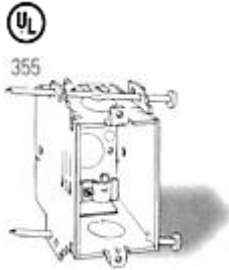

SWITCH BOXES
ARMORED CABLE/METAL CLAD/FLEX CLAMPS

APPLICATIONS:
STEEL SWITCH BOXES

- Wiring method may be conduit or cable connector.

PRODUCT FEATURES:
STEEL SWITCH BOXES

- Gangable switch boxes offer the option of constructing a box to hold two or more devices.
- Bracket boxes provide fast and accurate means of mounting the box to wood or metal studs.
- Plaster ears allow the box to be used in "old work" applications.

COMPLIANCES

[Click here](#) for complete information on UL and other compliances that apply to these products.

SWITCH BOXES

2¹/₂" DEEP
GANGABLE - WITH
ARMORED CABLE/METAL
CLAD/FLEX CLAMPS
12.5 CUBIC INCHES

RACO NO.	DESCRIPTION BRACKET & SETBACK	KNOCKOUTS				STD. COND. PKG.
		SIDES	ENDS	BOTTOM	COND.	
518	Ears	4	1 - 1/2"	50		
8518	Ears ■■■■	4	1 - 1/2"	50		
524	TS brkt., 1/2"	4	2 - 1/2"	1 - 1/2"	50	
8524	TS brkt., 1/2" ■■■■	4	2 - 1/2"	1 - 1/2"	50	
522	Long B, 5/8"	4	2 - 1/2"	1 - 1/2"	50	
8522	Long B, 5/8" ■■■■	4	2 - 1/2"	1 - 1/2"	50	
523	Old work, Griptite	4	1 - 1/2"	50		
8523	Old work, Griptite ■■■■	4	1 - 1/2"	50		

STEEL SWITCH BOXES



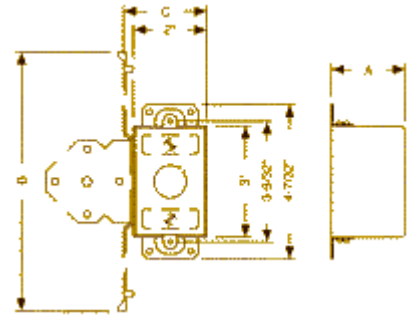
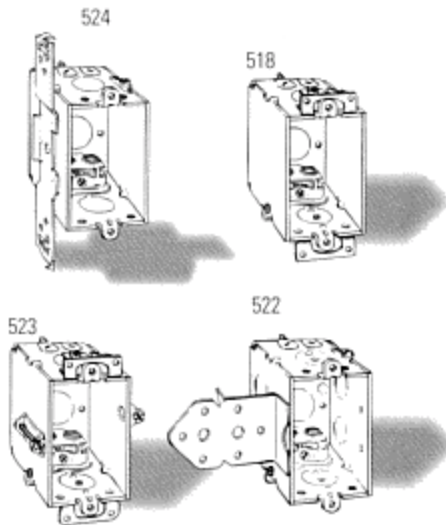

RACO NO.	A	B	C
518	2-1/2"	--	--
524	2-1/2"	7-5/32"	2-5/16"
522	2-1/2"	1-1/32"	5-3/64"
523	2-1/2"	--	--
526	2-1/2"	1-3/8"	3-13/32"

SWITCH BOX

**2 1/2" DEEP
NONGANGABLE - WITH
ARMORED CABLE/METAL
CLAD/FLEX CLAMPS
12.5 CUBIC INCHES**



526

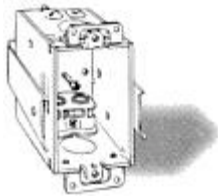

RACO NO.	DESCRIPTION BRACKET & SETBACK	KNOCKOUTS			STD. COND.	PKG.
		SIDES COND.	ENDS CABLE COND.	BOTTOM COND.		
526	Old work		4			20

CAT. NO. 353 SWITCH BOX

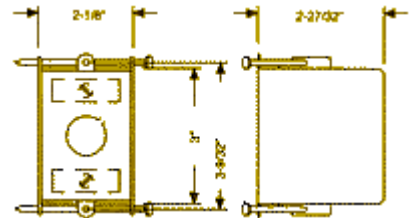

SWITCH BOX

**2 27/32" DEEP
NONGANGABLE - WITH
ARMORED CABLE/METAL
CLAD/FLEX CLAMPS
15.8 CUBIC INCHES**



353

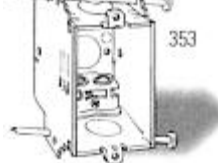

RACO NO.	DESCRIPTION BRACKET & SETBACK	KNOCKOUTS			STD. COND.	PKG.
		SIDES COND.	ENDS CABLE COND.	BOTTOM COND.		
353	S brkt., nails		4		1 - 1/2"	50

RACO SWITCH BOXES PAGE [1](#) [2](#) [3](#) [4](#) [PREVIOUS](#) [NEXT](#)

[TOP OF PAGE](#) [BACK TO RACO STEEL BOXES](#)
[CLICK HERE](#) OR USE YOUR BROWSER'S "BACK" BUTTON TO GO BACK
TO THE PAGE THAT REFERRED YOU HERE.

Information and specifications displayed on this site are subject to change without notice.

© 2001, [Cape Electrical Supply, Inc.](#)

The product images and information and Hubbell and Raco logos on this page were copied with permission from the Hubbell-Raco Electrical Products Catalog R-198 © [Hubbell Incorporated \(Delaware\)](#).

